



Innovation & Development

From the beginning...

At the beginning of the twentieth century the foundry shops then existing began producing wheel lathes for machining railway wheelsets. This type of production continues up to the present day and for more than a century, RAFAMET has served to meet the diverse needs of the metalworking industry.

Over the years, RAFAMET has become a global company and the most recognizable brand in the market of special purpose machine tools. Our company is a widely respected supplier of heavy-duty special-purpose machine tools for railway, machine-building, energy, shipbuilding, metallurgical, aerospace and arms industry.

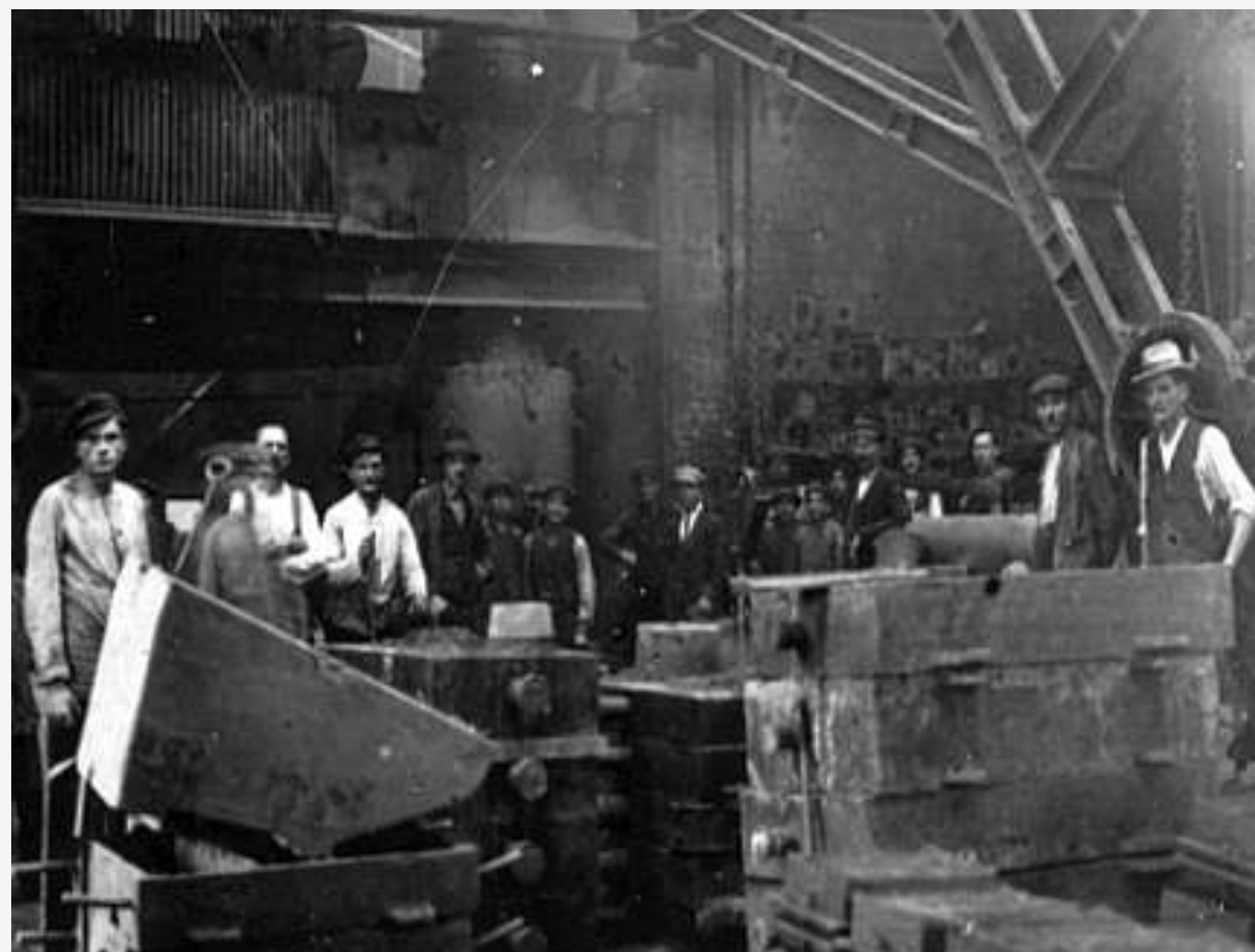

Timeline



1846

After the start-up of the Berlin - Vienna railway line (which ran through Kuźnia Raciborska), the first steel plant called "Hope" is founded right next to the railway station. In the second half of the nineteenth century, a rolling mill and an cast iron foundry is added.

1889

Takeover of the factory by Wilhelm Hegenscheidt. During that time, the factory is manufacturing various building equipment and products for railways (such as bolts and axles for wheel sets).

1920

The first lathe for machining of heavy wheel sets is produced.

1946

After World War II, the RAFAMET comes into being. During the next few years the company acts under the name "RAFO".

1964

As an economic experiment, RAFAMET (and three other Polish companies) acquires the right to independent export and import activities without the Central Foreign Trade Agencies.

1996

The company's shares are admitted to be traded on the over the counter market CeTO S.A., making it the first company in Poland to do so.

2002

ARP S.A. (Industrial Development Agency) becomes a main shareholder of RAFAMET S.A.

2016

Acquisition of the POREBA trademark

2021

The 75th anniversary celebration of RAFAMET S.A.

...until now



Now, just as back then, we are convinced that comprehensive solutions, advanced technologies and efficient productivity are obvious requirements the right equipment supplier is expected to meet in order to help various industries to be successful. That is why we are constantly adapting and continuing our efforts aimed at satisfying and serving customers' needs.

Whilst maintaining its traditional production RAFAMET continues to develop new product lines, using Company's own, engineering task force. Such a development, in recent years, has helped RAFAMET to be able to enter new manufacturing fields i.e. bridge type milling machines, horizontal axle lathes, special machines, modular machining centres and wheelset measurement systems.

RAFAMET S.A.



We are located at Staszica 1, 47-420
Kuźnia Raciborska, Silesia Region, Poland



The main shareholder of the Company
is ARP S.A. (Industrial Development Agency) – 91.27%



RAFAMET employs over 550 qualified employees

RAFAMET

Solid task force

Engineering & programming

Thanks to Company's own, highly-qualified engineering & programming task force, equipped with Solid Edge, EdgeCAM, AutoCAD and Simatic Step 7 software, as well as our extensive knowledge and hands-on experience in applications, we offer the best engineering solutions to our customers. Furthermore, for our company innovation processes are often based on close collaboration with customers.

Highly qualified, creative & experienced staff

From the concept, through production, to the maintenance phase – RAFAMET makes every effort to keep machine in peak operating condition. Therefore, we provide professional training and technical service. During installation, operators and maintenance staff receive specific training on how to use and maintain the machine in order to ensure its best performance and fault-free operations.

RAFAMET Group

RAFAMET S.A. is the parent company in the group of six organizationally separated units. Each of them has the set of clearly defined strategic goals to achieve, as well as the specified share in the RAFAMET Group overall business activities.



RAFAMET

Machine Tools

is one of the worldwide leading companies in the field of designing and manufacturing medium and large size heavy-duty machine tools, including vertical turning & boring lathes.



RAFAMET

Railways

is focused on machine tools for wheelset machining (wheels and axles), rail vehicle bogies. It also offers rail-road shunting vehicles, as well as measuring devices for the wheel geometry and flaw detection.



POREBA

Machine Tools

are CNC super heavy duty, heavy duty and medium centre and floor-type horizontal lathes, as well as large horizontal drilling machines and drilling & boring machines for deep hole drilling.



RAFAMET

Service & Trade

is providing after-sale services including technical support repairs and modernisations of the machine tools. Also offers the products complementary to the basic assortment of the RAFAMET Group units.



RAFAMET

Foundry

is a well-known manufacture of iron castings made from grey, ductile and alloy iron, which specializes in the production of large and heavy castings in small-batch series, weighing more than 5,000 kg.



RAFAMET

Large Part Machining

is directed to a selected group of customers interested in contract machining services on the large size CNC milling machines, as well as vertical turning and milling centres.

International presence

80

Countries around the world



5500

machines for railways

750

other heavy-duty machine tools

76

years of experience, innovation and quality

80

% export share in total sales

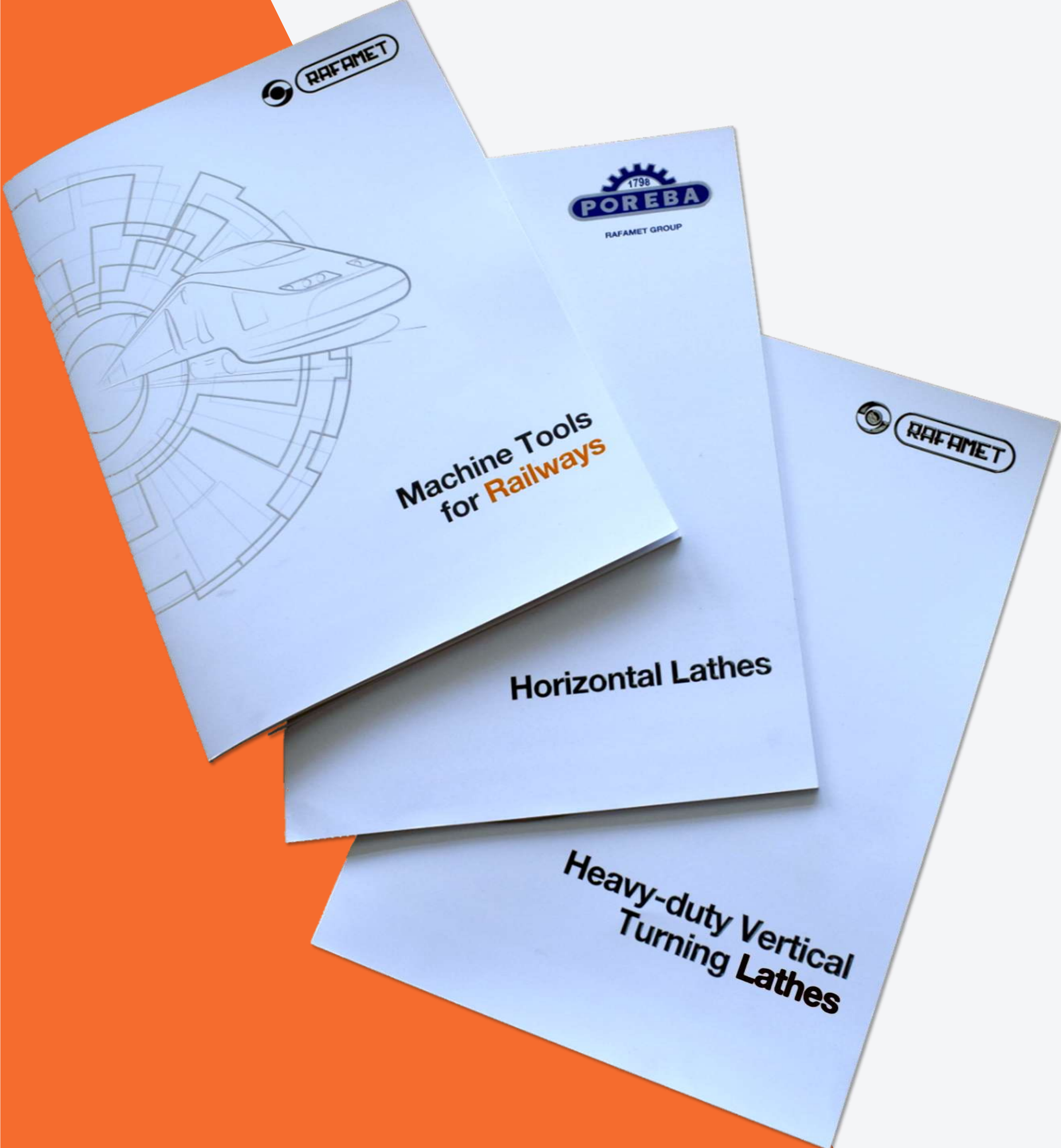

Product line

MACHINE TOOLS FOR RAILWAYS

Above Floor Wheel Lathes

The RAFAMET above wheel lathes are built on the base of extremely rigid, single-piece, heavily-ribbed, high-grade grey iron casting of the main structure, allowing operation in roll-in roll-out or roll-through systems and providing efficient chip disposal. Surface wheel lathes are able to execute operations, including turning wheel profiles according to a technological program, facing of brake-disc friction surfaces and turning of wheel centres.

UBF 112 N

ABOVE FLOOR WHEEL LATHES
ROLL-IN ROLL-OUT / CHUCK TYPE

- ✓ Track gauge [mm]: 1435 *
- ✓ Min./Max. wheel tread diameter [mm]:
700 or 800 / 1120 or 1250
- ✓ Max. width of wheel rim [mm]: 145
- ✓ Min./Max. length of wheelset axle [mm]:
1910 / 2360
- ✓ Max. weight of wheelset [x10 kN]: 3



* Another track gauge to be agreed upon.

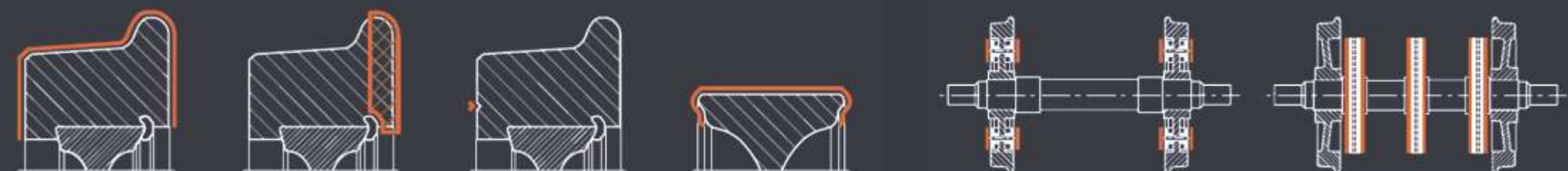

UDA 125 N

ABOVE FLOOR WHEEL LATHES

ROLL-THROUGH / RADIAL OR AXIAL CLAMPING

- ✓ Track gauge [mm]: 1435 *
- ✓ Min./Max. wheel tread diameter [mm]:
600 or 770 / 1250 or 1200
- ✓ Max. width of wheel rim [mm]: 145
- ✓ Min./Max. length of wheelset axle [mm]:
1645 / 2370
- ✓ Max. weight of wheelset [x10 kN]: 4.5



* Another track gauge to be agreed upon.

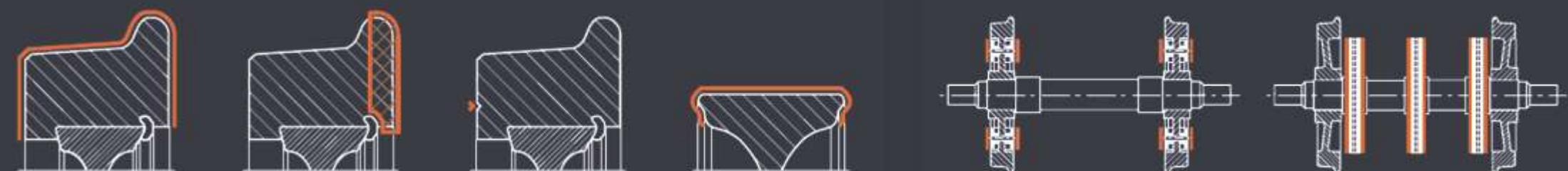

UFB 125 N

ABOVE FLOOR WHEEL LATHES

ROLL-IN ROLL-OUT / FRICTION ROLLER DRIVE

- ✓ Track gauge [mm]: 1000 to 1676 *
- ✓ Min./Max. wheel tread diameter [mm]: 600 / 1250
- ✓ Max. width of wheel rim [mm]: 150
- ✓ Min./Max. length of wheelset axle [mm]: 1215 / 2840
- ✓ Max. weight of wheelset [x10 kN]: 3



* Adjustable track gauge in the range of 1000 to 1676 mm available.



UFD 140 N

ABOVE FLOOR WHEEL LATHES ROLL-THROUGH / FRICTION ROLLER DRIVE

- ✓ Track gauge [mm]: 1435 *
- ✓ Min./Max. wheel tread diameter [mm]:
540 / 1400
- ✓ Max. width of wheel rim [mm]: 150
- ✓ Min./Max. length of wheelset axle [mm]:
1650 / 2600
- ✓ Max. weight of wheelset [x10 kN]: 5

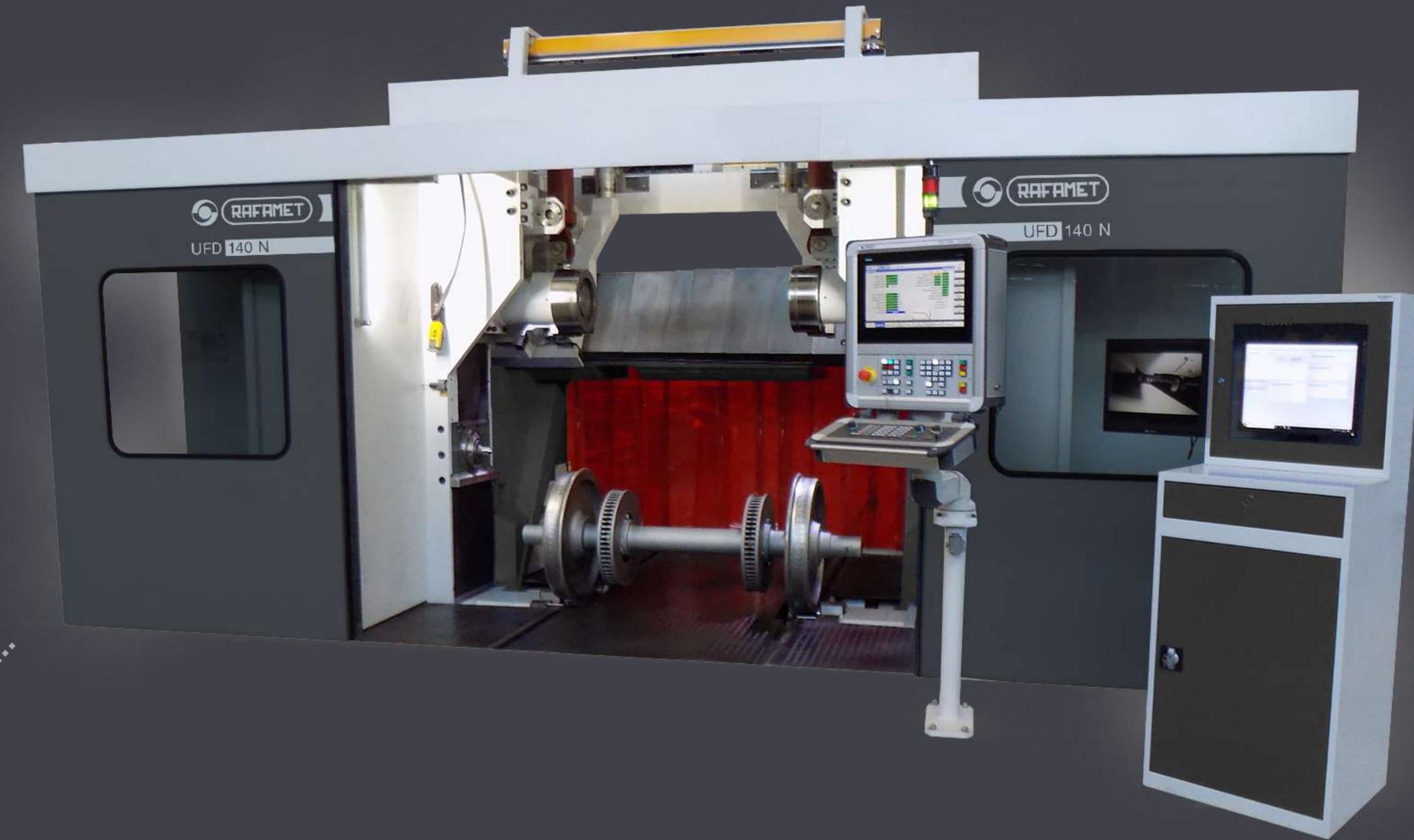

* Another track gauge to be agreed upon.



MACHINE TOOLS FOR RAILWAYS

Underfloor Wheel Lathes

Available in both single and tandem versions, the machines are designed for turning wheel profiles and facing brake discs of one or two wheelsets at the same time. The machines are set below the rails. Permanent and retractable rails connecting with the floor rails to form a track allow the vehicle to travel over the machines. The machines can be provided with many optional elements and devices, including vehicle shunting arrangements, as well as dust extraction and swarf evacuation systems.

UGE 180 N

UNDERFLOOR WHEEL LATHE

ROLL-THROUGH / SINGLE OR TANDEM VERSION

- ✓ Track gauge [mm]: 1435 *
- ✓ Min./Max. wheel tread diameter [mm]: 350 / 1270
- ✓ Max. width of wheel rim [mm]: 145
- ✓ Continuously variable cutting speed for wheel profile machining [m/min]: 20 to 90
- ✓ Max. axle load [x10 kN]: 18 / 30

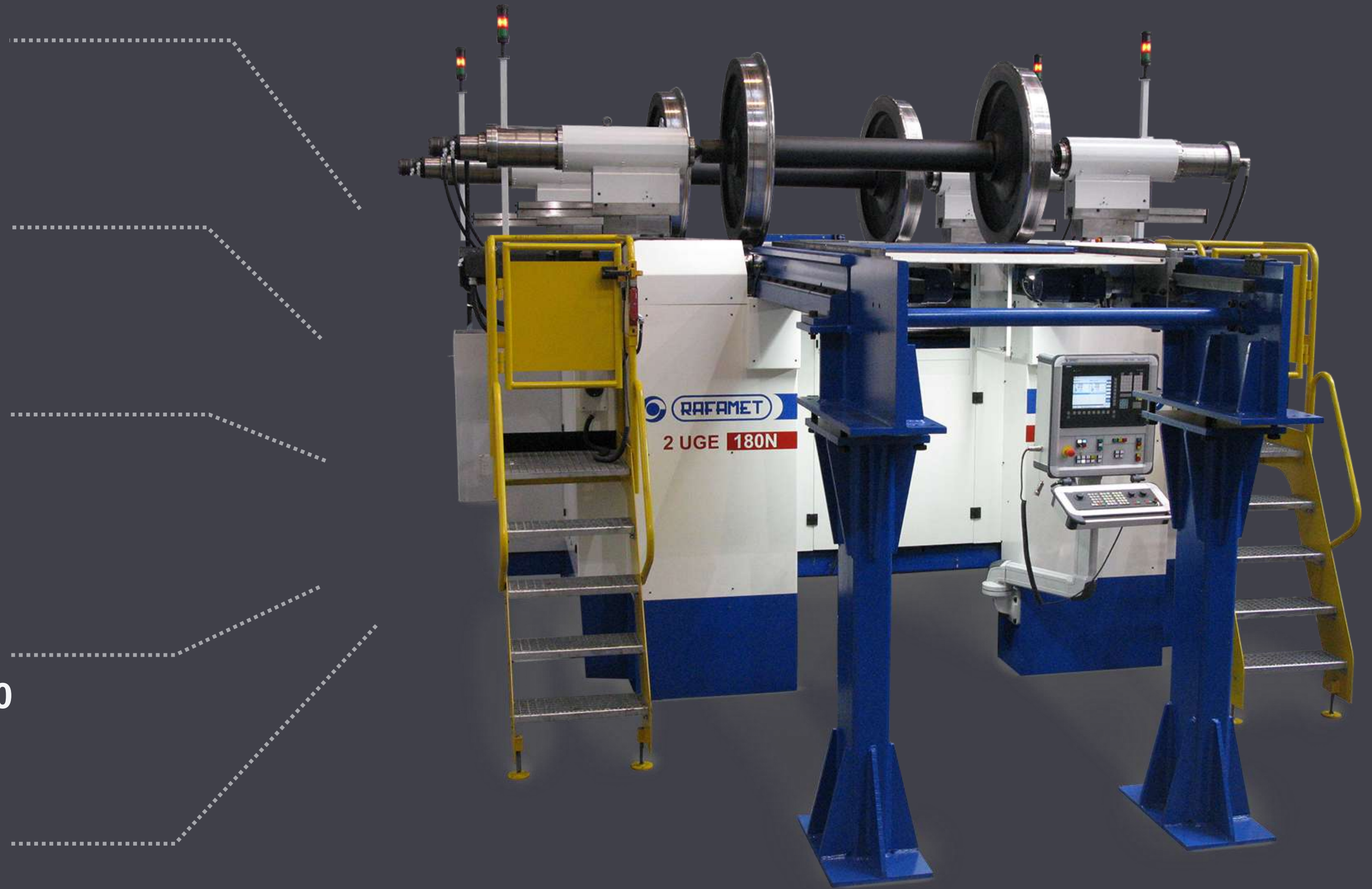

* Another track gauge to be agreed upon.

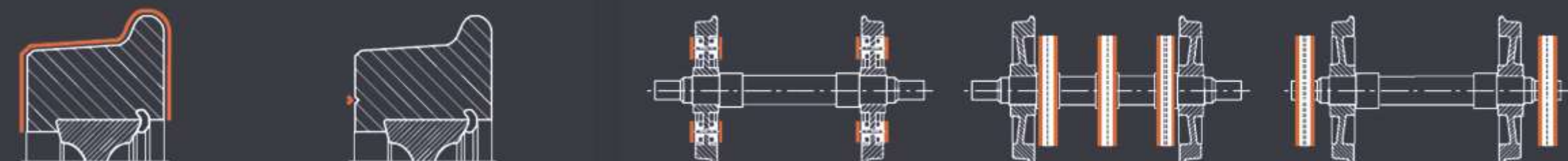

UGE 300 N

UNDERFLOOR WHEEL LATHE

ROLL-THROUGH / SINGLE OR TANDEM VERSION

- ✓ Track gauge [mm]: 1435 *
- ✓ Min./Max. wheel tread diameter [mm]: 600 / 1500
- ✓ Max. width of wheel rim [mm]: 150
- ✓ Continuously variable cutting speed for wheel profile machining [m/min]: 20 to 90
- ✓ Max. axle load [x10 kN]: 30 / 40

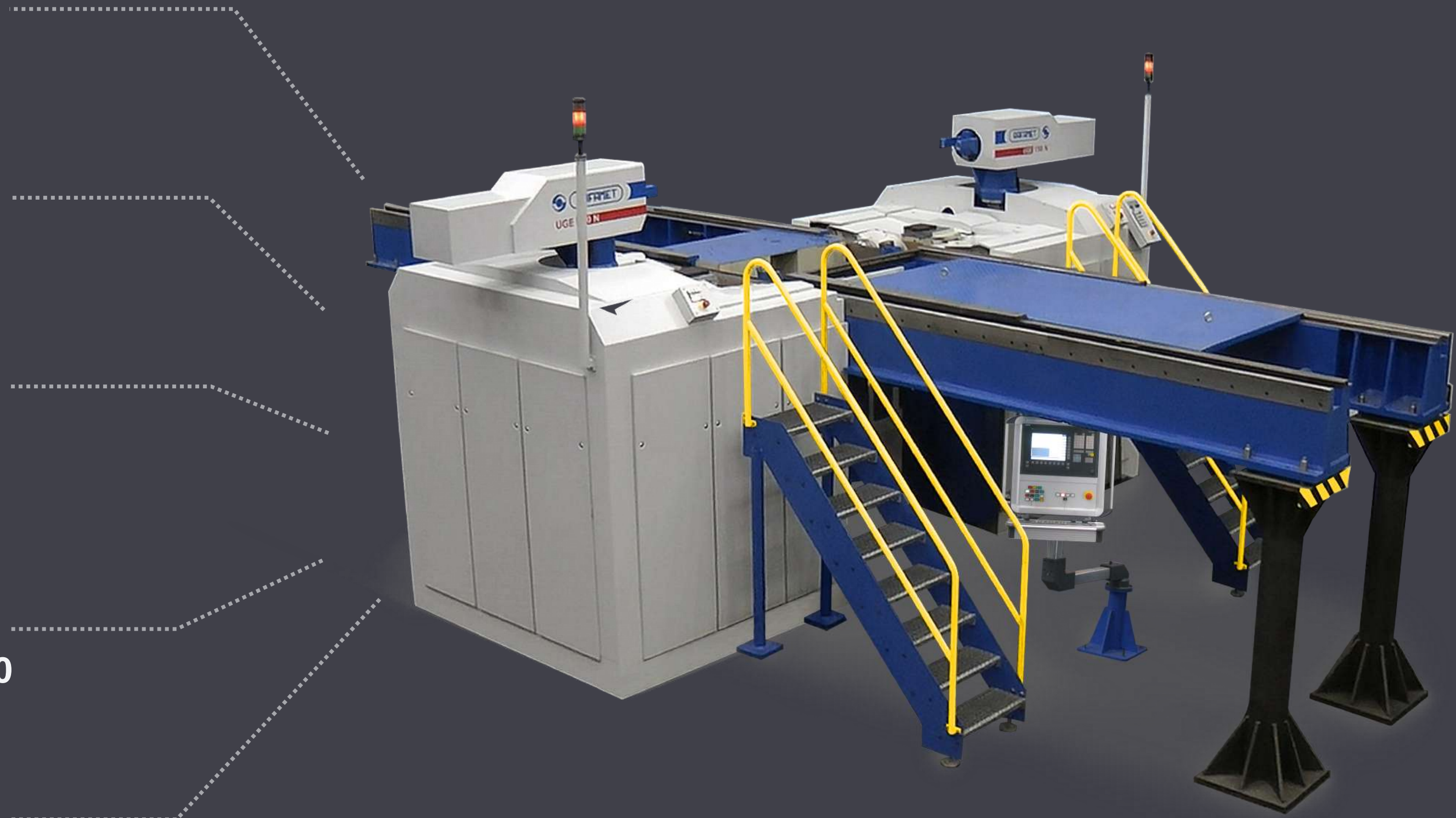

* Another track gauge to be agreed upon.

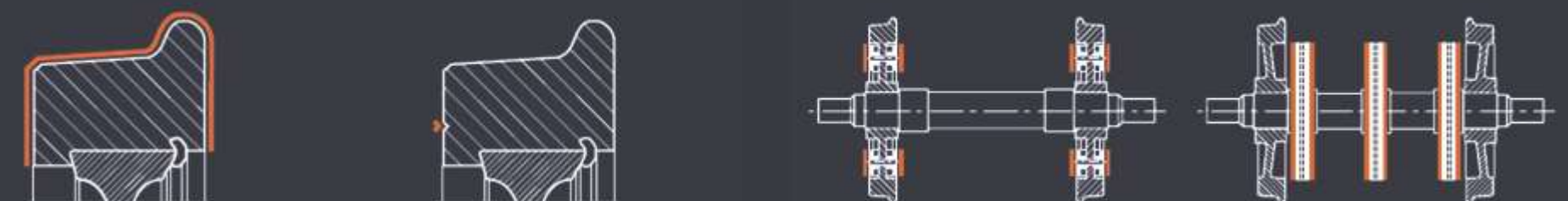

- ✓ Track gauge [mm]: 1435 *
- ✓ Min. turning radius [m]: 30
- ✓ Tractive force [kN]: min. 17.5
- ✓ Max. speed on road and rails without load [kmph]: 6
- ✓ Max. speed on rails with load [kmph]: 2
- ✓ Max. weight to shunt [t]: 350 / 800



* Another track gauge to be agreed upon.

Wheel Turning Machines

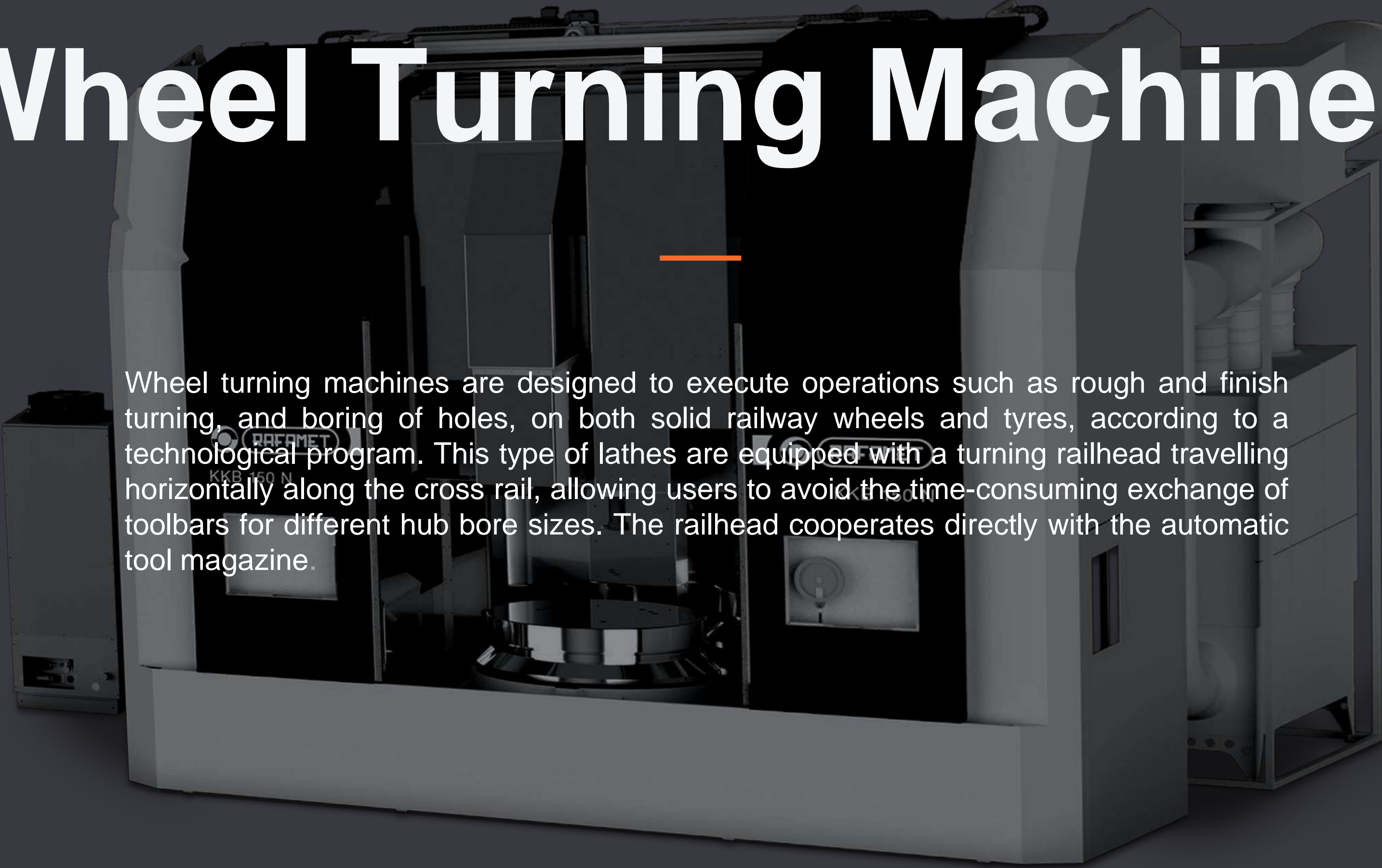

Wheel turning machines are designed to execute operations such as rough and finish turning, and boring of holes, on both solid railway wheels and tyres, according to a technological program. This type of lathes are equipped with a turning railhead travelling horizontally along the cross rail, allowing users to avoid the time-consuming exchange of toolbars for different hub bore sizes. The railhead cooperates directly with the automatic tool magazine.

KCM 150 N

WHEEL BORING MACHINES

- ✓ Table diameter [mm]: 1500
- ✓ Max. turning diameter [mm]: 1800
- ✓ Max. wheel tread diameter [mm]: 1250
- ✓ Max. weight of workpiece [x10 kN]: 6
- ✓ Max. continuously variable rotation rates of table [rpm]: 250
- ✓ Power of main drive [kW]: 55 or 110



KKB 150 N

WHEEL TURNING MACHINES

- ✓ Table diameter [mm]: 1450
- ✓ Max. turning diameter [mm]: 2000
- ✓ Max. wheel tread diameter [mm]: 1250
- ✓ Max. weight of workpiece [x10 kN]: 2
- ✓ Max. continuously variable rotation rates of table [rpm]: 400
- ✓ Power of main drive [kW]: 362.5

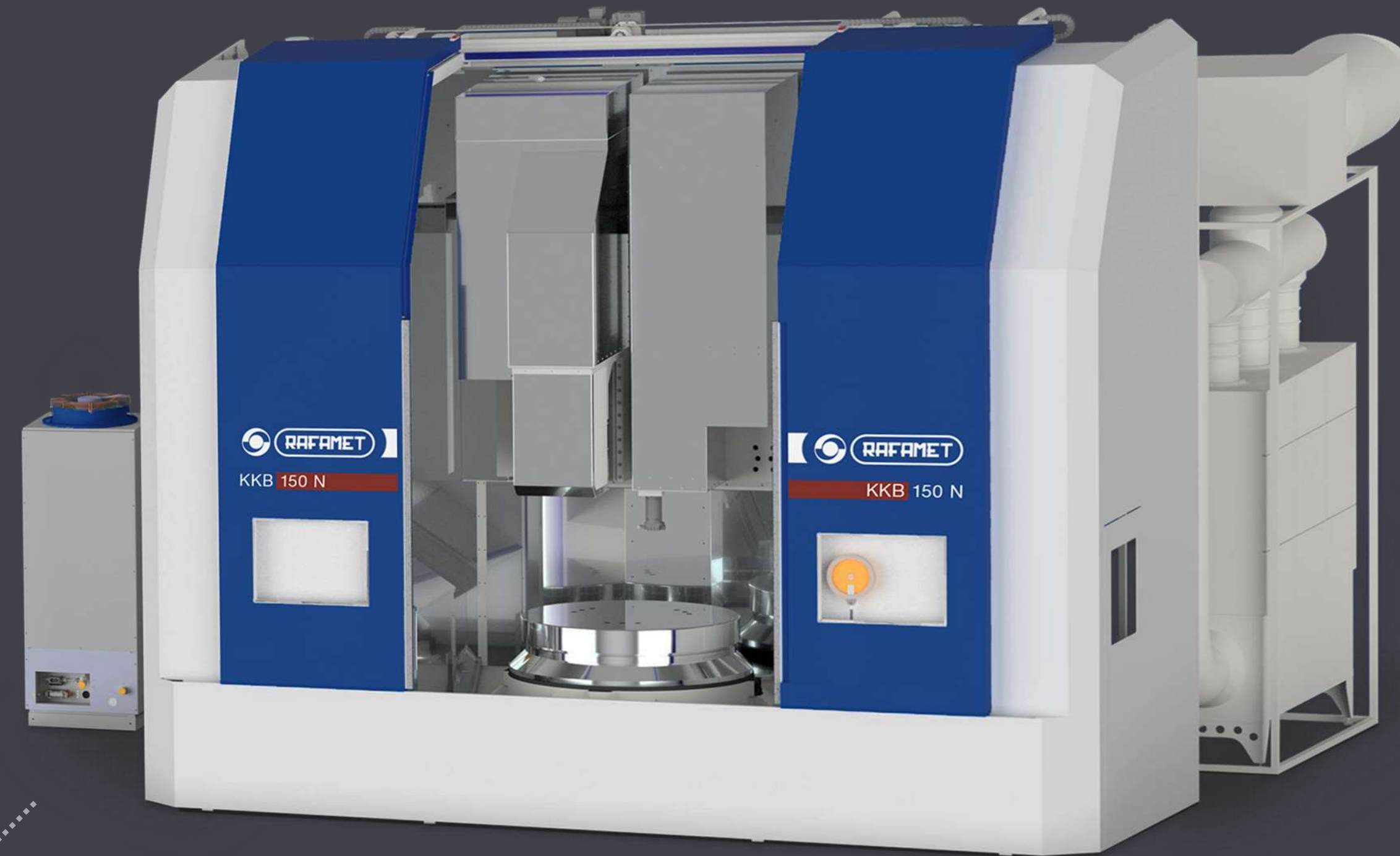

MACHINE TOOLS FOR RAILWAYS

Horizontal Lathes For Axles & Wheelsets

A slant-bed axle lathe enables to perform turning and burnishing of outboard & inboard journals, axle, conical or curvilinear surfaces. The machine tool can also perform rough and finish turning of new and worn railway axles. Some of them are able to even reprofile wheels and brake discs used in rail vehicles.

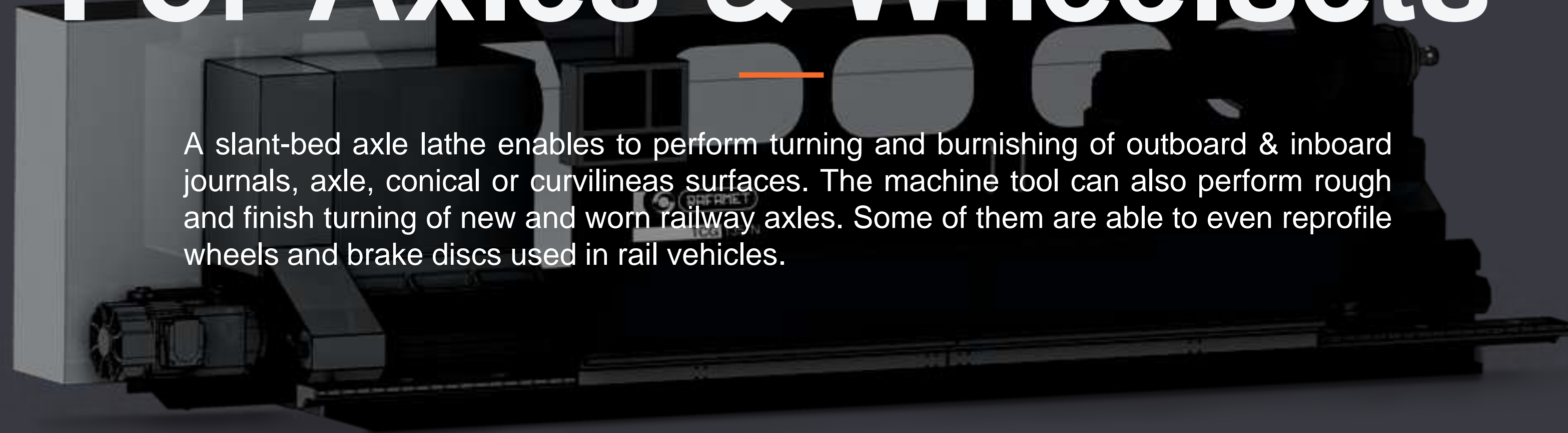

TOK 80 N

HORIZONTAL LATHES FOR AXLES

- ✓ Swing over bed [mm]: 800
- ✓ Swing over carriage [mm]: 670
- ✓ Max. distance between centres [mm]: 2800
- ✓ Max. weight of workpiece [x10 kN]: 6



TCG 135 N

HORIZONTAL LATHES FOR AXLES AND WHEELSETS

- ✓ Track gauge [mm]: 1435 *
- ✓ Min./Max. wheel tread diameter [mm]: 600 / 1250
- ✓ Max. width of wheel rim [mm]: 145
- ✓ Min./Max. length of wheelset axle [mm]: 2800
- ✓ Max. weight of wheelset [x10 kN]: 3

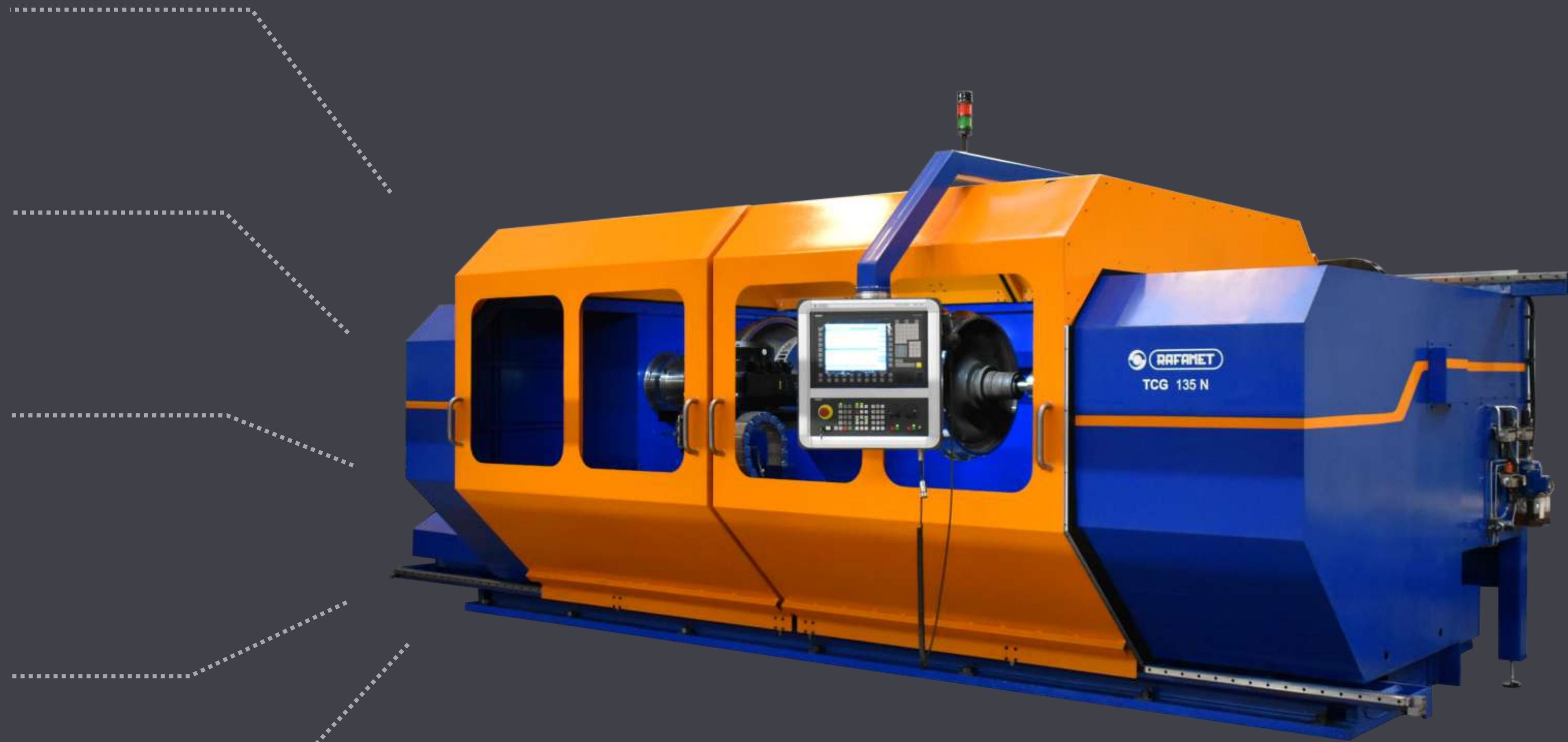

* Another track gauge to be agreed upon.

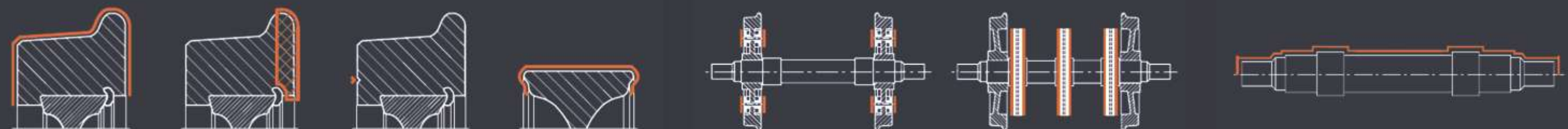

EQUIPMENT FOR RAILWAYS

Measurements, Diagnostics & Database Systems

The large measuring systems like real-time track condition evaluation systems for track geometry vehicles, stationary wheel geometry control systems, and diagnostic databases for rolling stock wheels maintenance planning.

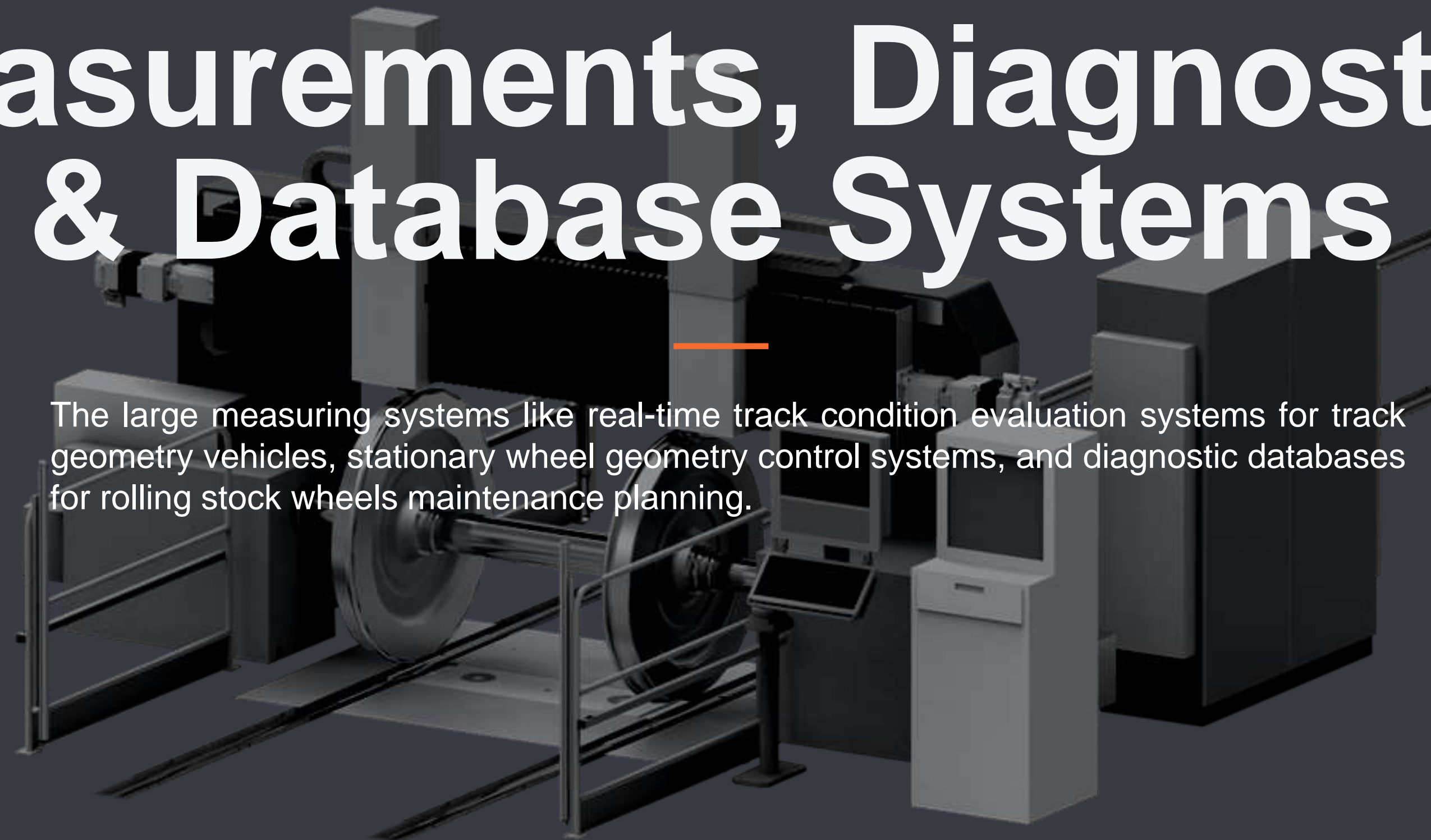

SP 125 N

MEASURING STATION

- ✓ Track gauge [mm]: 1435 *
- ✓ Min./Max. wheel tread diameter [mm]:
600 / 1250
- ✓ Min./Max. length of wheelset axle [mm]:
1720 / 2600
- ✓ Rapid travel [mm/min]: 5000
- ✓ Max. weight of wheelset [t]: 3



* Another track gauge to be agreed upon.

MEASURING & DIAGNOSTIC SYSTEMS



The laser measuring system for wheelsets is designed for monitoring of wheel profile wear. The degree of wheel profile wear is determined on the base of a virtual picture of wheel surface created from the measured data.*

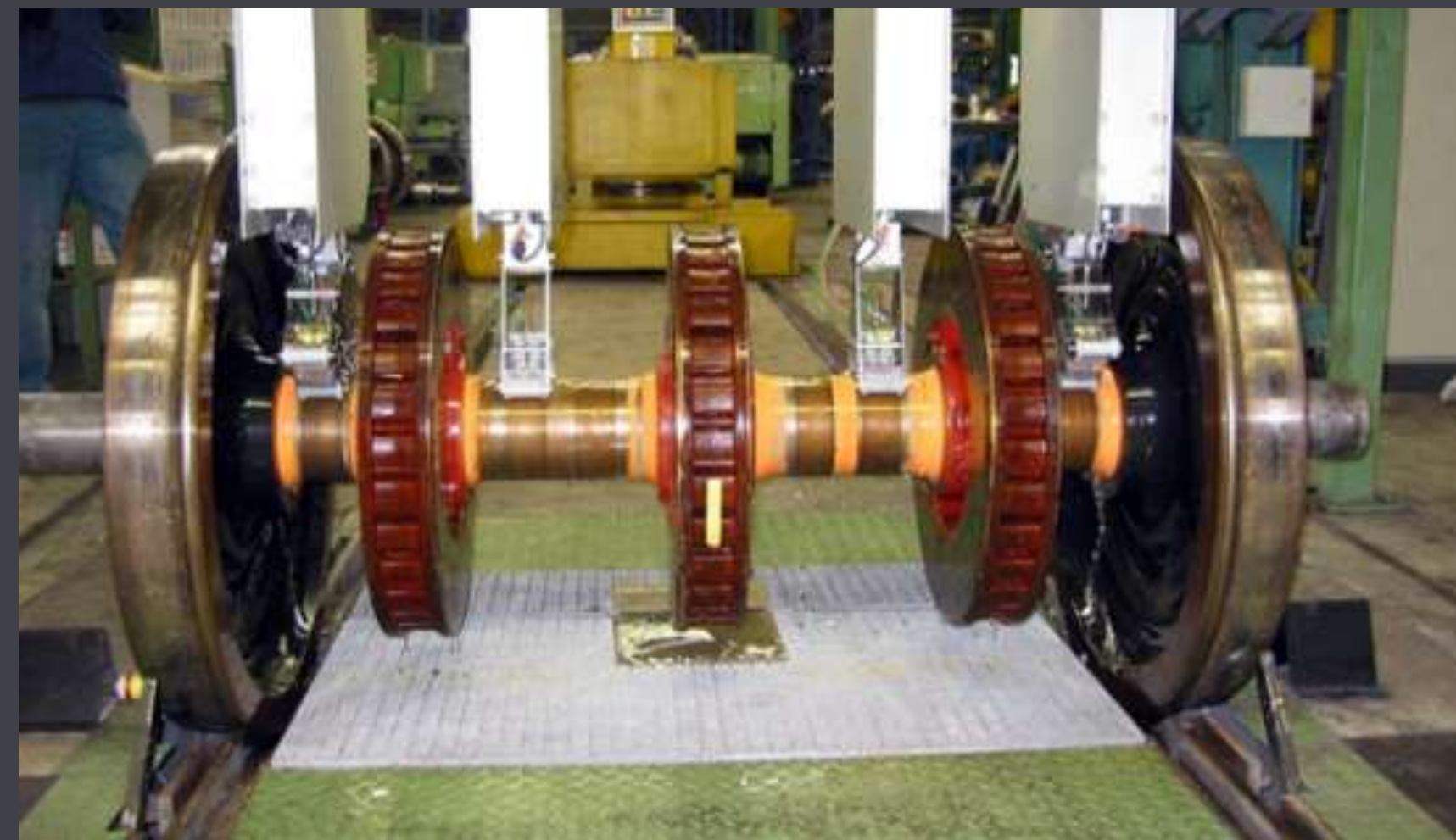

The wheelset ultrasonic flaw detection system is based on the multi-encoder heads using the phased array ultrasonic inspection technology. It is delivered as a separate inspection station.



The wheel profile flat spot detection system operates on the base of vibrations recorded by a series of vibroacoustic sensors installed in track while a vehicle is running on the length of approximately 10 meters.*

* The offer elaborated in cooperation with the GRAW company, a supplier of track and rolling stock wheel measuring systems.

DATABASE SYSTEM

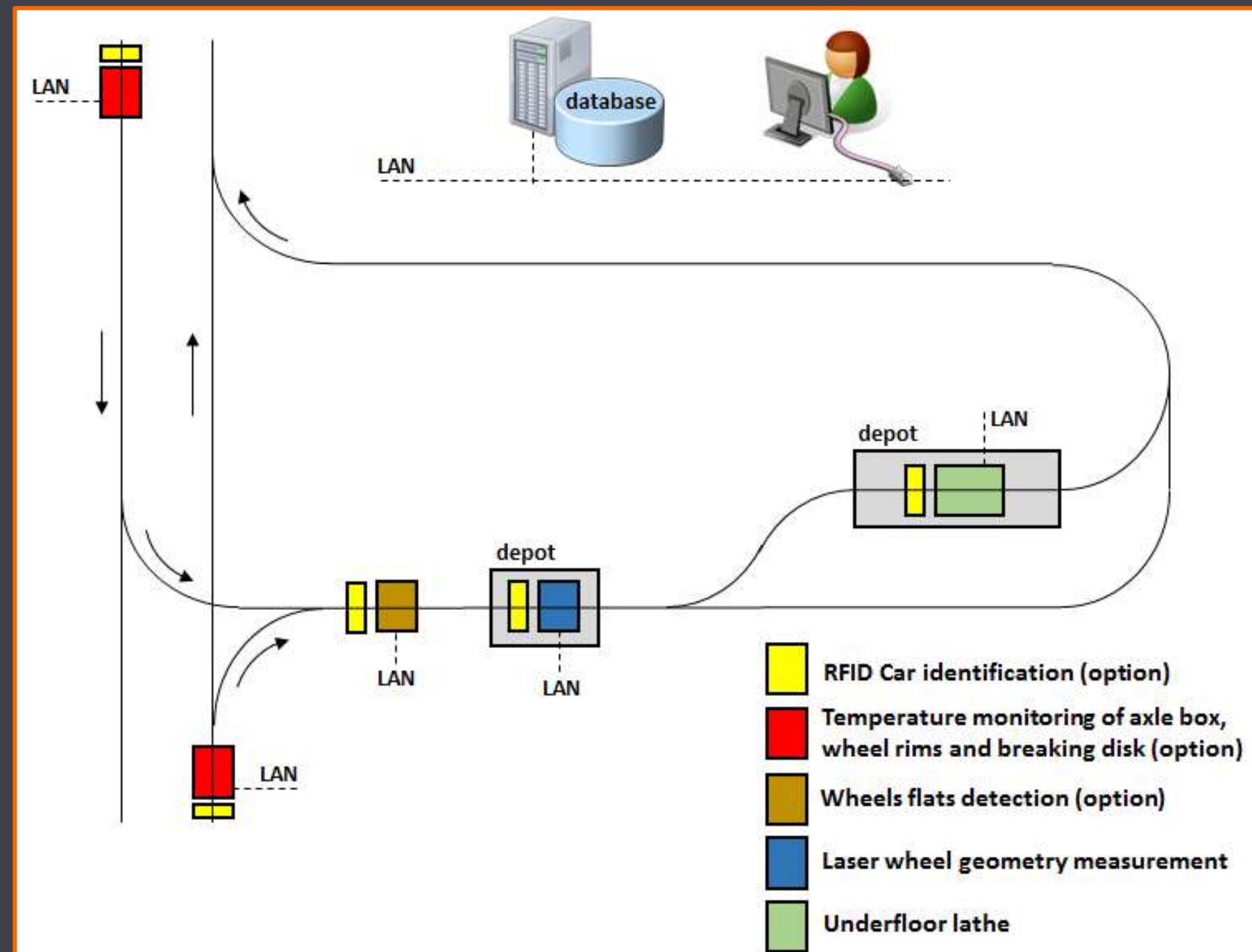

Automatic procedures of measurements without involving operator.



All the data measured by each module are collected and stored in the local database, which can be accessed through Ethernet connection.



The vehicles and wheelsets are identified and suitably assigned prior to the measurements.



The system is delivered with the diagnostic and analytic modules and all the measured data are stored in the main database.

* The offer elaborated in cooperation with the GRAW company, a supplier of track and rolling stock wheel measuring systems.

MACHINE TOOLS FOR GENERIC MACHINE APPLICATION

Vertical Turning Lathes

The heavy-duty vertical turning lathes are intended to perform turning and boring operations of cylindrical, conic, and curved surfaces as well as complex-shaped large-size workpieces of weight up to 350 tonnes, of outer diameter up to 16,000 mm, and of height of turning up to 7,000 mm. The application of the CNC system provides automatic and productive machining controlled by technological program.

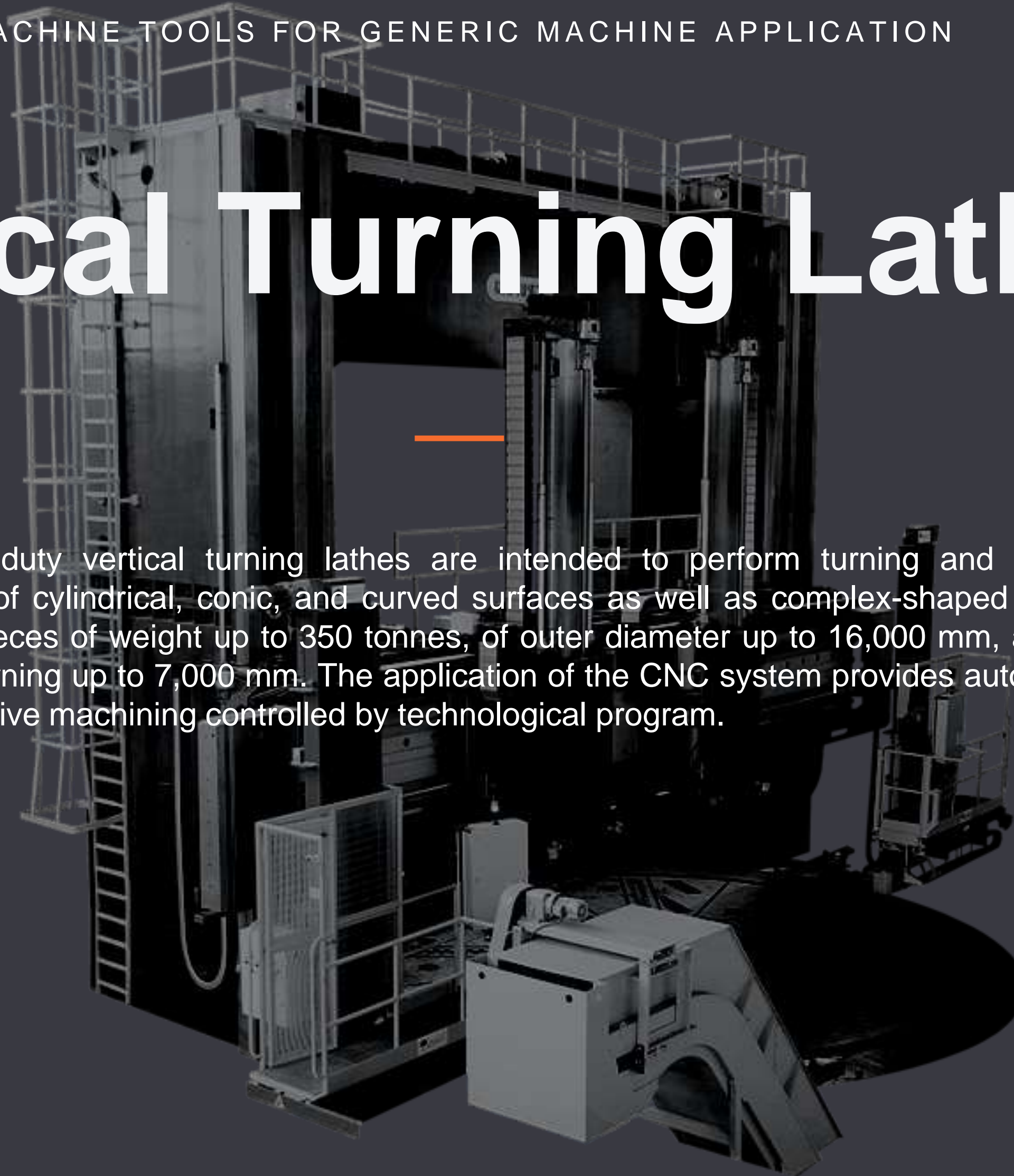

KCM 150 N

VERTICAL TURNING LATHES

- ✓ Max. table diameter [mm]: 1500
- ✓ Max. swing diameter [mm]: 2000
- ✓ Max. turning height [mm]: 1800
- ✓ Max. weight of workpiece [x10 kN]: 30

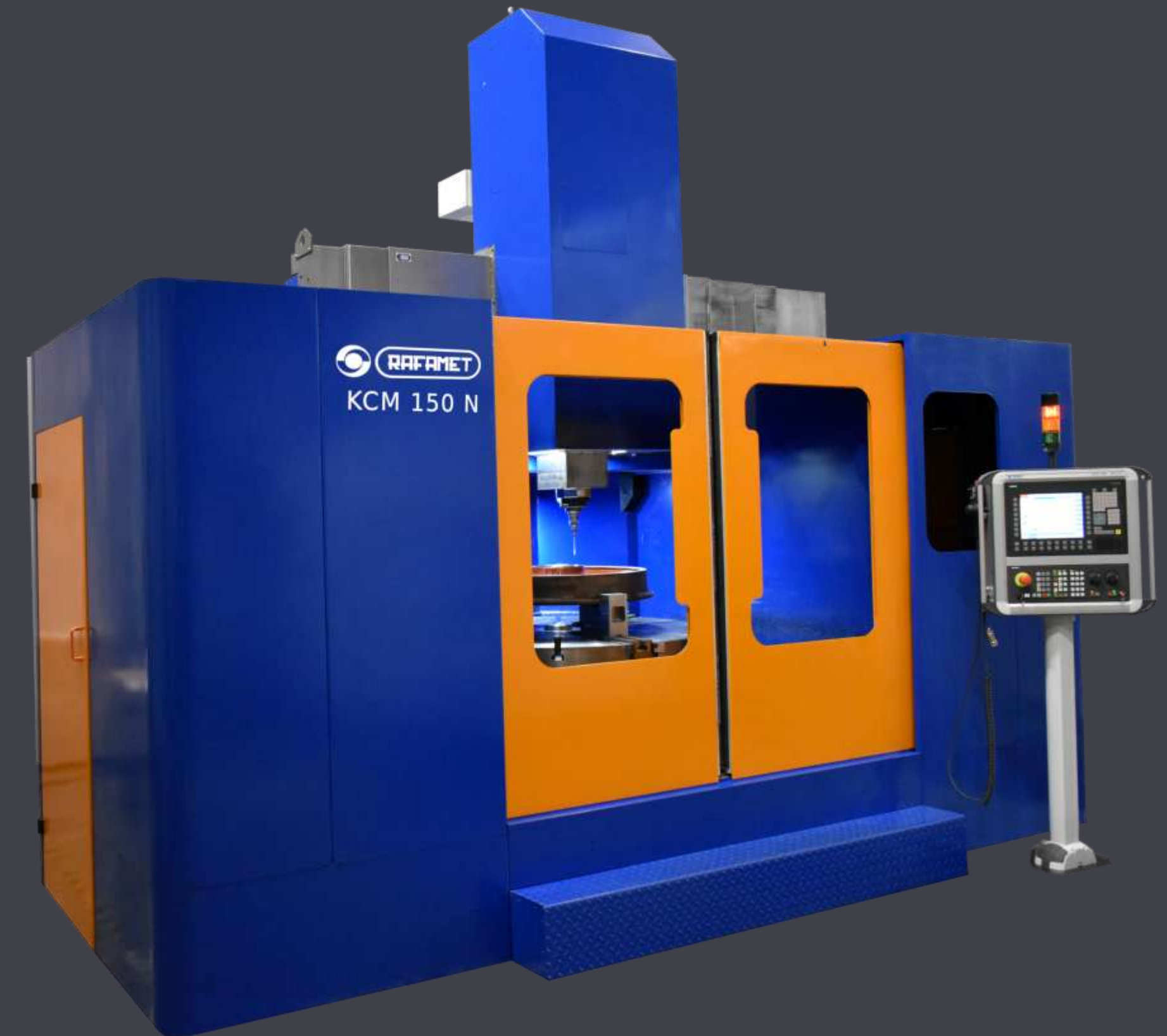

KCI 250-500 N

VERTICAL TURNING LATHES

- ✓ Max. table diameter [mm]: 7000
- ✓ Max. swing diameter [mm]: 8000
- ✓ Max. turning height [mm]: 5000
- ✓ Max. weight of workpiece [x10 kN]: 150

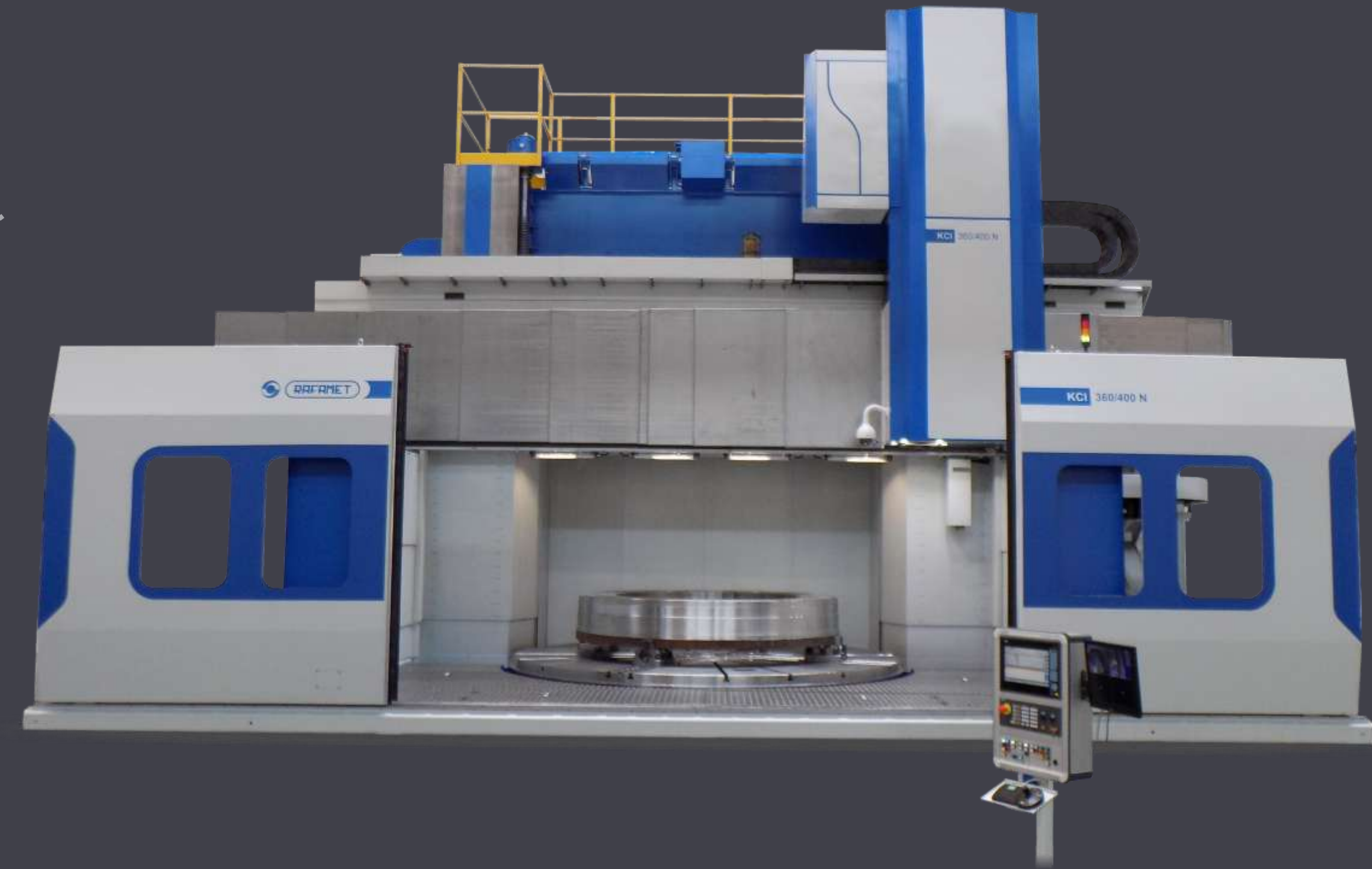

KDC 700 N

HEAVY DUTY VERTICAL TURNING LATHES

- ✓ Max. table diameter [mm]: 10000
- ✓ Max. swing diameter [mm]: 13000
- ✓ Max. turning height [mm]: 8000
- ✓ Max. weight of workpiece [x10 kN]: 350



MACHINE TOOLS FOR GENERIC MACHINE APPLICATION

Special Milling Machines

The Special Purpose Milling Machines that we offer to our customers, can be used in various metalworking workshops and industries. They are available with a large variety of auxiliary equipment, including tool heads with automatic tool change to provide maximum flexibility when machining large, complex workpieces.

GMC 320-400 N

SPECIAL MILLING MACHINES

- ✓ Gantry with fixed or movable cross-rail (CNC W axis)
- ✓ 3D milling, drilling, reaming, boring, threading or envelope threading in all machining planes
- ✓ All movable assembly units travel along precise rolling or hydrostatic guideways
- ✓ Electro permanent magnetic system for chucking of rails available



FS 550 N

SPECIAL MILLING MACHINES

- ✓ Heavy-duty milling of webs of crank-throws used in vessel engines crankshafts.
- ✓ Rough and fine milling of inner surfaces of crank-throw webs
- ✓ Rough milling of crank-throw pins
- ✓ The entire machining process is controlled by CNC system and proprietary technological program.

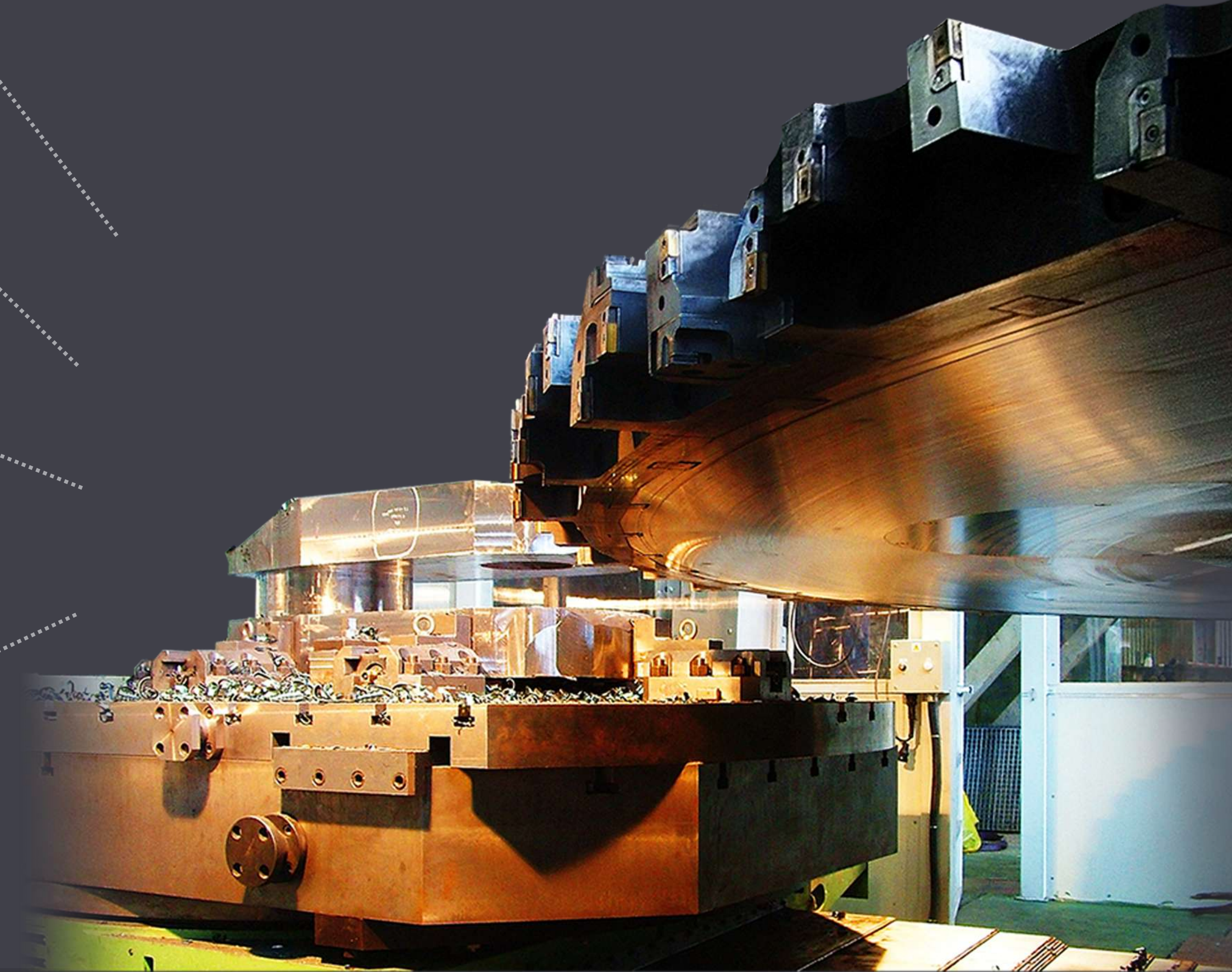

MACHINE TOOLS FOR GENERIC MACHINE APPLICATION

Horizontal Lathes

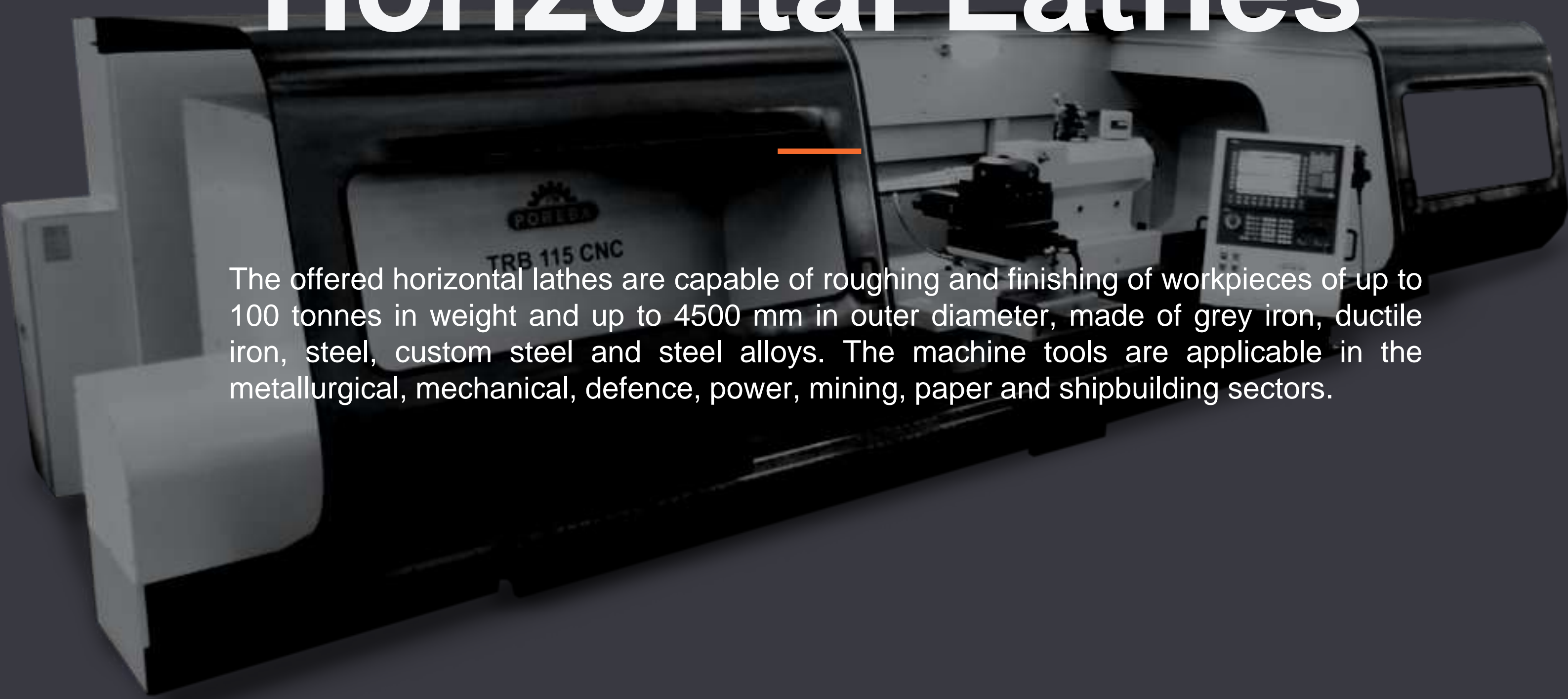

The offered horizontal lathes are capable of roughing and finishing of workpieces of up to 100 tonnes in weight and up to 4500 mm in outer diameter, made of grey iron, ductile iron, steel, custom steel and steel alloys. The machine tools are applicable in the metallurgical, mechanical, defence, power, mining, paper and shipbuilding sectors.

POREBA Horizontal lathes

✓ Max. swing over bed [mm]: 6000

✓ Max. length of workpiece [mm]: 33000

✓ Max. weight of workpiece [t]: 120

✓ Model lines:
TOK, TRP, TRB, TCM , TCF, TCE, TZL

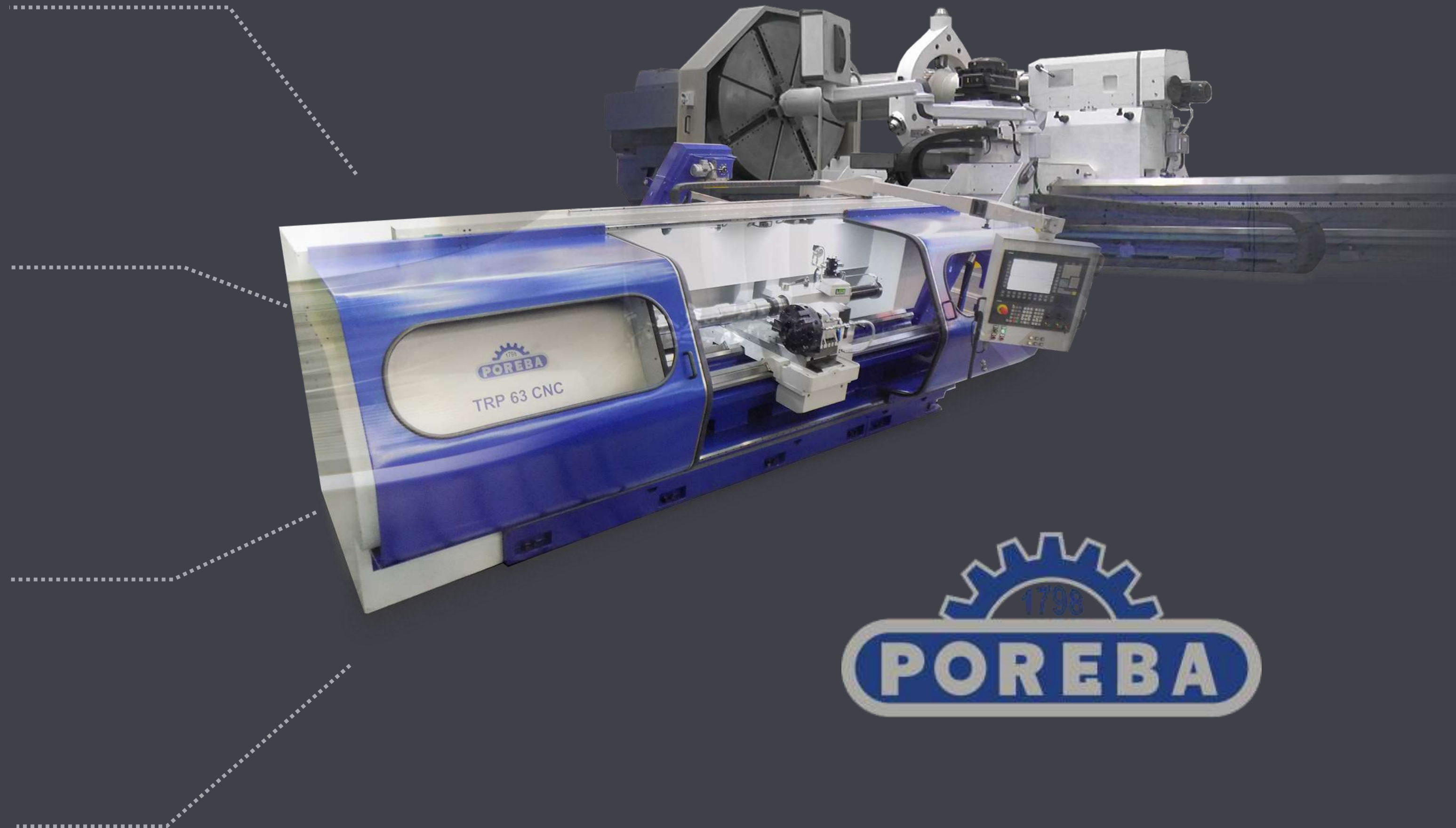

TRP 63 CNC

CENTRE LATHES

- ✓ Swing over bed [mm]: 650
- ✓ Swing over carriage [mm]: 380
- ✓ Max. weight of workpiece [t]: 4,6
- ✓ Turning length (mm): 1000 - 8000

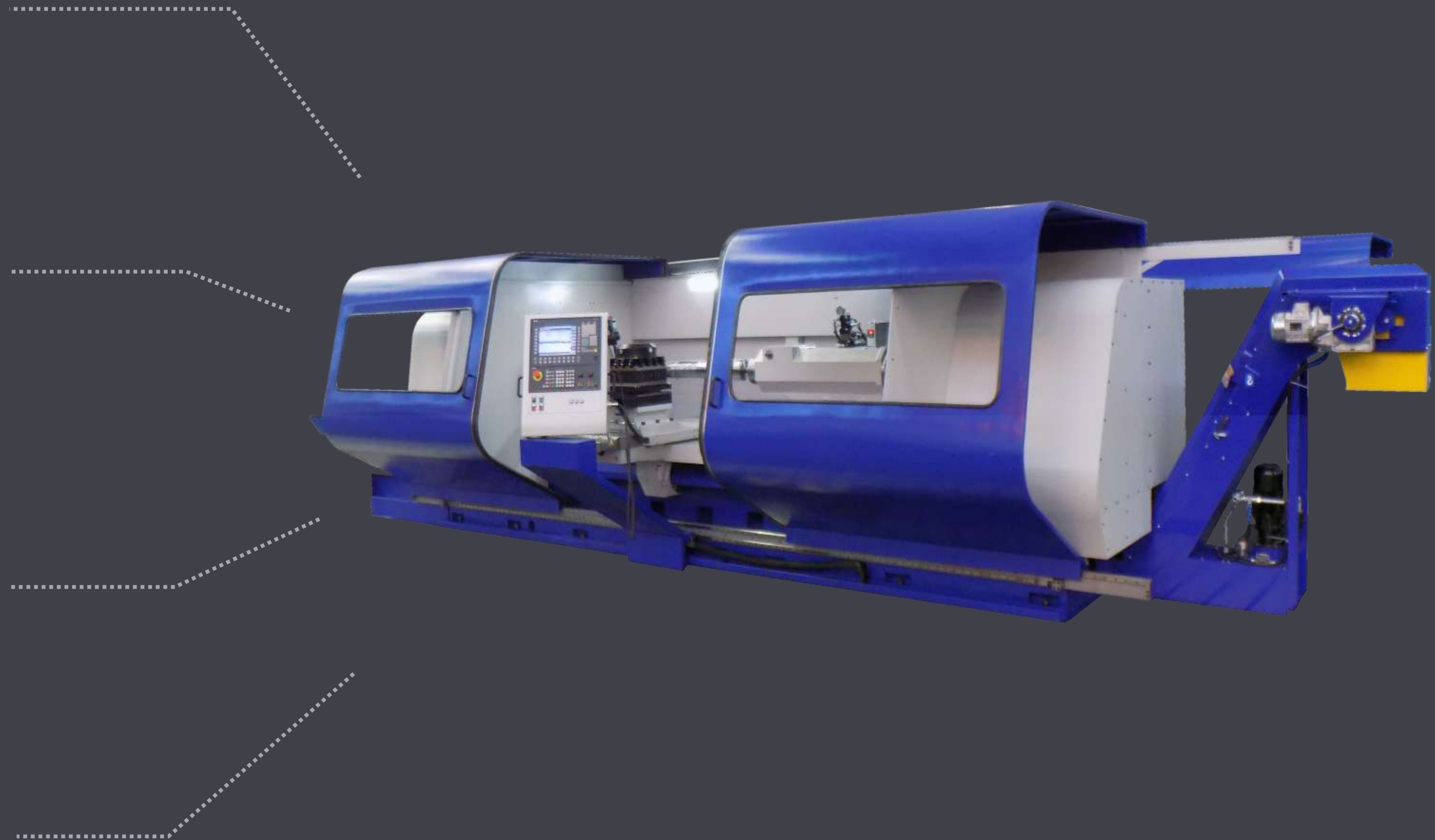

TCF 200 CNC

HEAVY CENTRE LATHES

✓ Swing over bed [mm]: 2000

✓ Swing over carriage [mm]: 1600

✓ Max. weight of workpiece [t]: 40

✓ Distance between centres (mm):
3000 - 25000

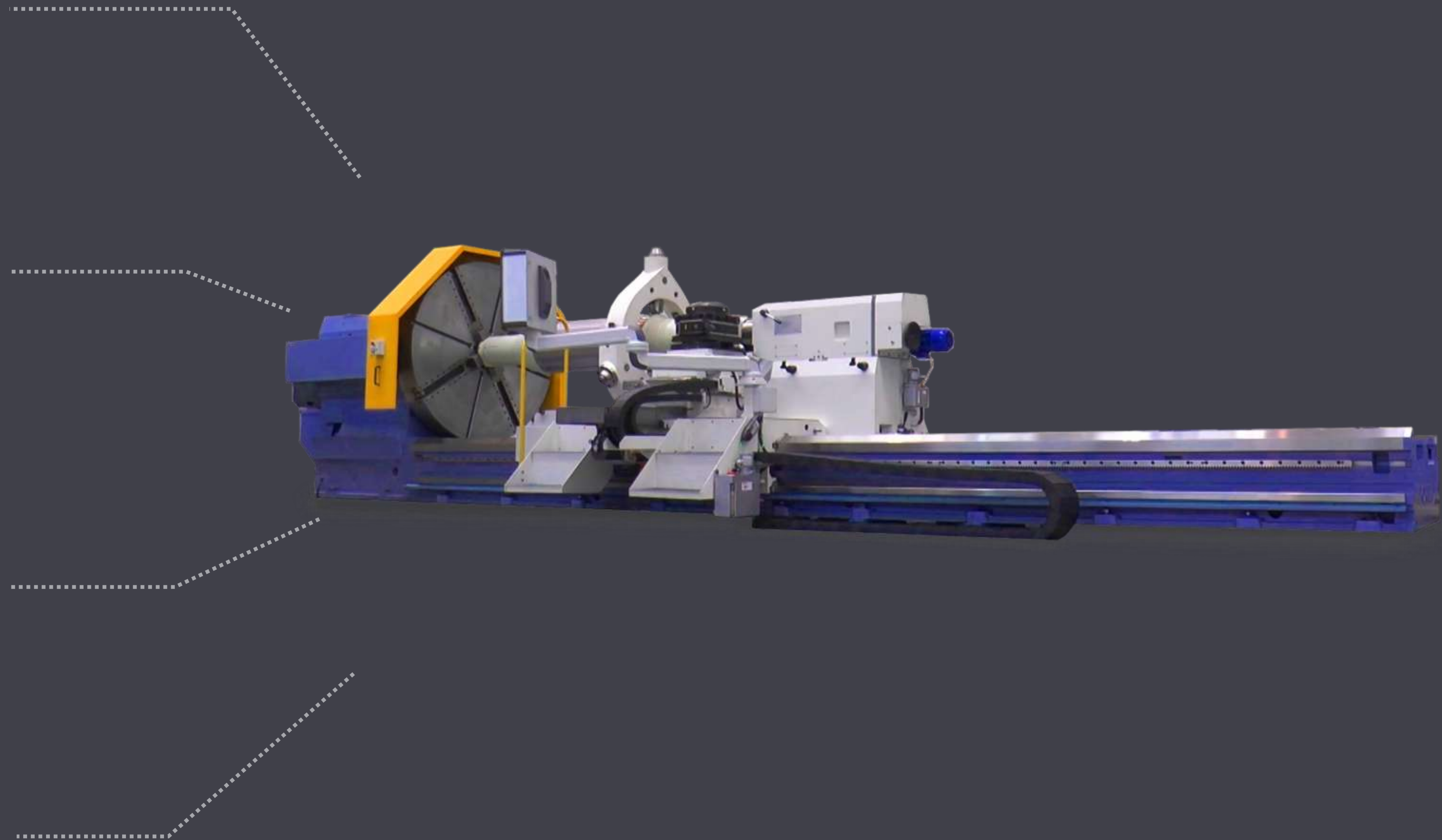

SERVICE & TECHNICAL SUPPORT



Warranty Services

- Full warranty support of supplied machines
- After-sales services



After-sale Services

- On-line and at-site technical support
- Delivery of spare parts
- Overhauls & upgrades of supplied machines

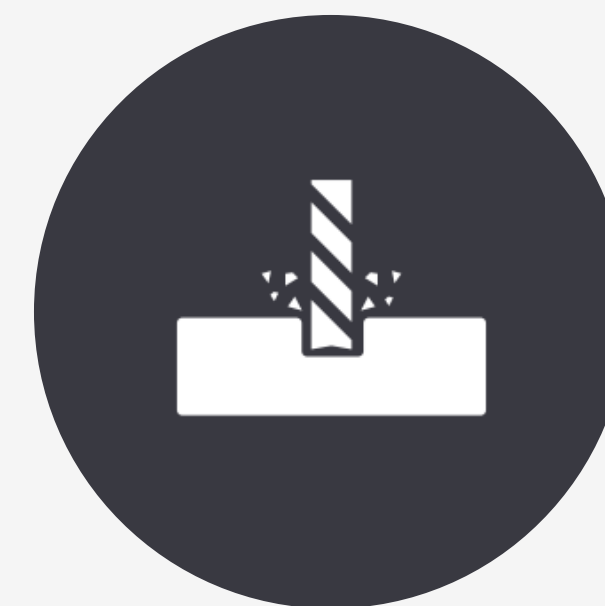

Large part workpiece machining

- Horizontal & vertical turning
 - Milling
 - Horizontal boring
 - Grinding
 - Honing
- Milling & grinding of gears

INTEGRATED MANAGEMENT SYSTEM

Sales of products and services to Customer's satisfaction while keeping safe work conditions and respecting natural environment is our Principal Goal.



RAFAMET FOUNDRY

CASTINGS



Grey iron

- EN-GJL 200
- EN-GJL 250
- EN-GJL 300
- EN-GJL 350
- Castings of single-piece weight up to **40000 kg**



Ductile iron

- EN-GJS 400-18
- EN-GJS 400-15
- EN-GJS 400-12
- EN-GJS 500-7
- EN-GJS 600-3
- EN-GJS 700-2
- Castings of single-piece weight up to **30000 kg**



Special alloy cast iron

- Ni-hard
- Ni-resist
- Castings of single-piece weight up to **20000 kg**

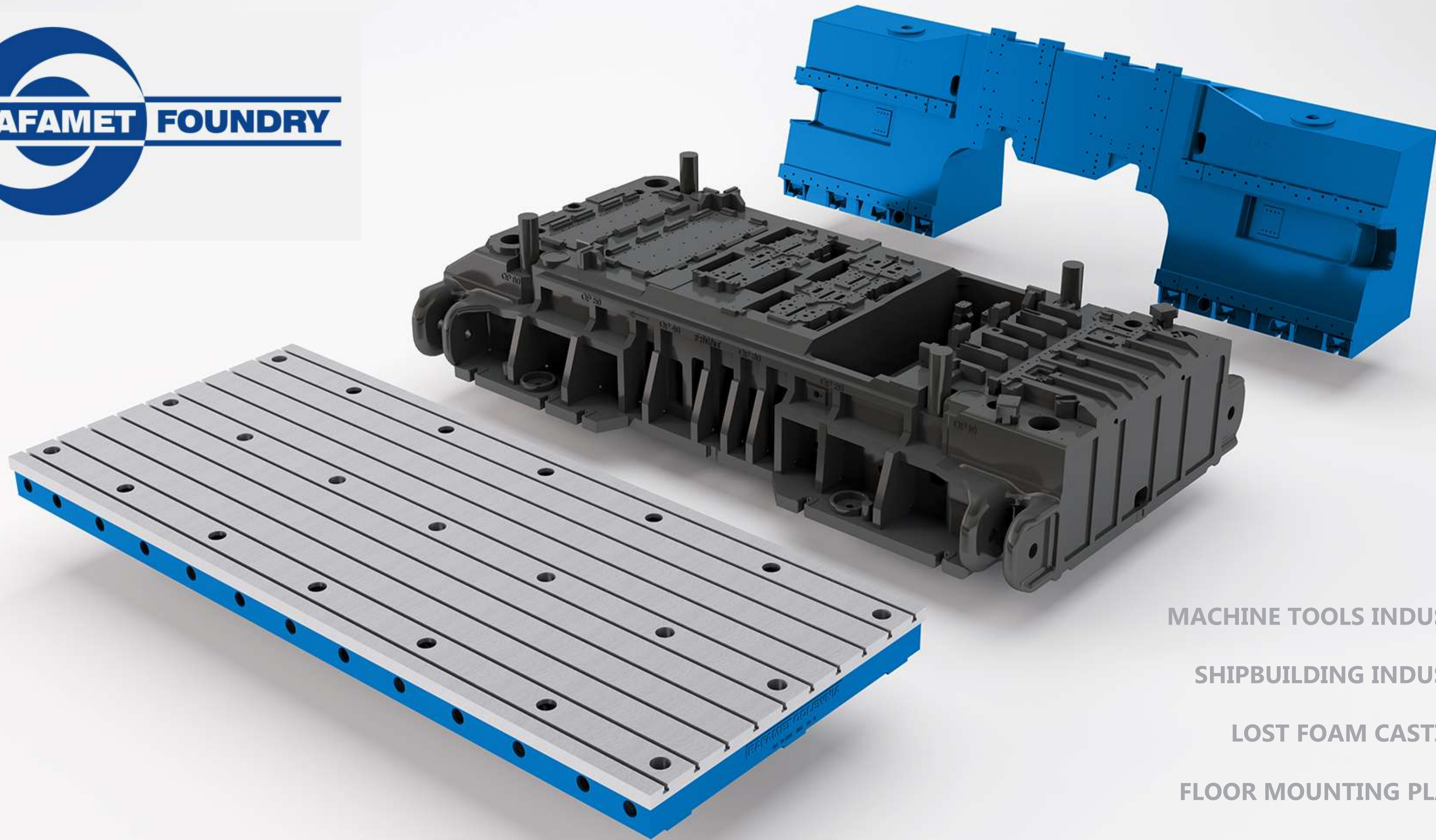

MACHINE TOOLS INDUSTRY

SHIPBUILDING INDUSTRY

LOST FOAM CASTINGS

FLOOR MOUNTING PLATES



© 2022

SHOULD YOU REQUIRE ANY FURTHER INFORMATION, PLEASE DO NOT HESITATE TO CONTACT US:

RAFAMET S.A., STASZICA 1, 47-420 KUŹNIA RACIBORSKA, POLAND

RAFAMET@RAFAMET.COM.PL